

# RECTANGULAR PROFILES

## TECHNICAL SPECIFICATIONS

**ADROIT.**

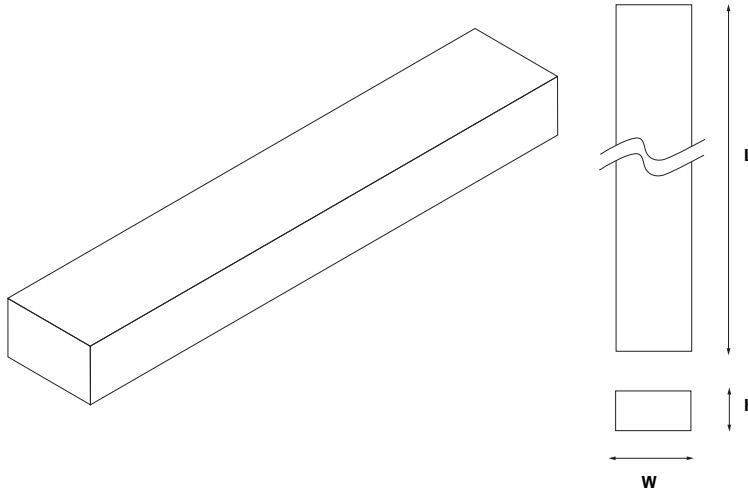







YOUR PROJECT. YOUR WAY. BE ADROIT.



### PRIMARY APPLICATION

EcoTuff™ profiles are an alternative to both softwood and hardwood material. If you have used metal, concrete, or timber in your design you can easily substitute EcoTuff™ rectangular profiles. Unlike the alternatives EcoTuff™ will not rot, rust, splinter or require maintenance. EcoTuff™ is a recycled plastic composite that is stronger than softwoods. Each kilogram of EcoTuff™ diverts 990grams of waste from landfill. Increase your ROI, safety and project longevity by substituting an EcoTuff™ profile.

### D CHART

Profile Type (PT)	Height (mm)	Width (mm)	Maximum Section Length (mm)	Weight (Kg/m)
RE015	50	30	2400	1.45
RE020 	75	45	6000	3.5
RE025	75	50	2400	3.54
RE030	100	25	6000	2
RE032	100	50	6000	4.2
RE040 	110	60	6000	6.8
RE041	110	65	6000	5.2
RE060 	140	40	6000	5.7
RE070 	150	100	6000	15.4
RE083 	200	20	6000	4.1
RE084	200	40	6000	7
RE086 	200	50	6000	10.4
RE087 	200	75	6000	15.6
RE088 	200	100	6000	20.8
RE110 	230	130	6000	31

### FEATURES

- No toxic treatments to leach into the environment or end users.
- Co-mingled material means timber performance with no warping or significant expansion & contraction.
- Won't rot so can be used totally submerged where required.
- EcoTuff™ is UV stabilized to ensure a longer lasting look for your project.
- Lighter weight than steel or concrete means easier installation with less people and equipment.
- Splinter free nature and lack of sharp edges reduces exposure to liability.
- 100% recycled post consumer waste feedstock means your decision is great for the environment.
- Extruded material so can be produced in most shapes, dimensions or lengths.

### OPTIONS

- Available in a large range of standard sizes and lengths.
- We can mill profiles into bollards, posts with holes or just about any other option.

### MODELS

**Profile Type (PT)** - PT XXX – To specify the size you want refer to the D Chart to choose a Profile Type and then build your specification code as shown.

ADROIT-**RE030**-4200-SC (example)

**Section Length (SL)** – Specify your section length in mm up to the maximum section length.

ADROIT – RE030-**4200**-SC (example)

### Colour (CC)

SC - Charcoal Grey  
 HG- Heritage Green  
 IB - Blue  
 TC- Terracotta

EcoTuff™ is only available in SC.

ADROIT – SQ030-4200-**SC** (example)